

# Fresh 90

**A B C D E F H**

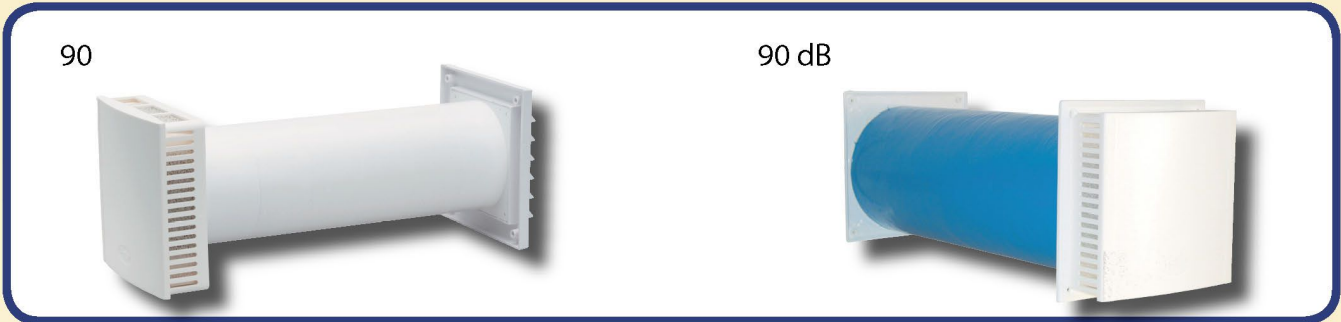

90

90 dB

Fresh 90, Ø99mm	
Lp.	
1	część wewnętrzna Fresh 90
2	przejście ściennie Ø99 x 150mm
3	kratka zewnętrzna #140

Fresh 90-dB, Ø140mm	
Lp.	
1	część wewnętrzna Fresh 90 włączając przykrywe #165
2	rura tłumiąca dB Ø81/140 x 400mm
3	zewnętrzna kratka dB włączając przykrywe #165

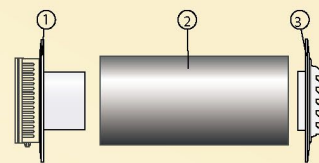
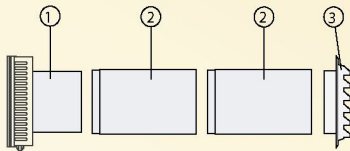

## Tłumienie hałasu dla nawiewnika 90 dB

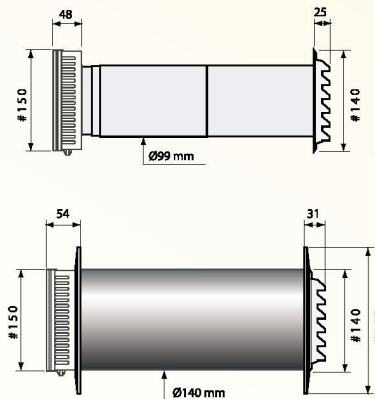
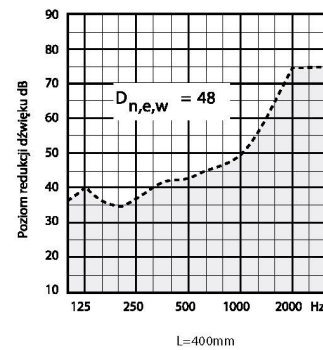
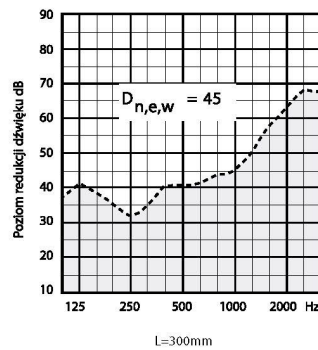
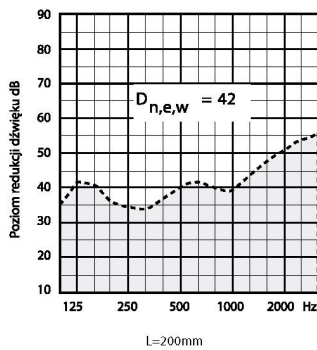

## Wydajność

