

Fresh 100 THERMO

A B C D E F H

100 Thermo

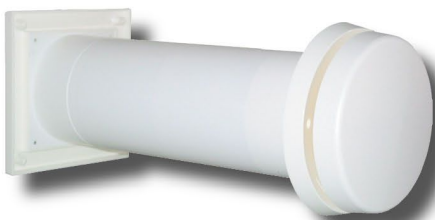

100 Thermo dB

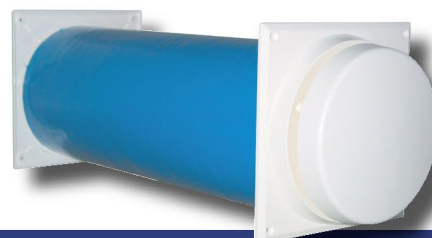

Fresh 100 Thermo, Ø99mm

Lp.	
1	regulator nawiewu Fresh 100 Thermo z termostatem
2	przejście ściennie Ø95/99 x 150mm
3	kratka zewnętrzna #140

Fresh 100 Thermo dB, Ø140mm

Lp.	
1	regulator nawiewu Fresh 100 Thermo dB z termostatem
2	rura tłumiąca dB Ø98/140 x 400mm
3	zewnętrzna kratka 100 Thermo dB

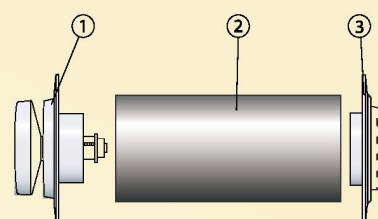
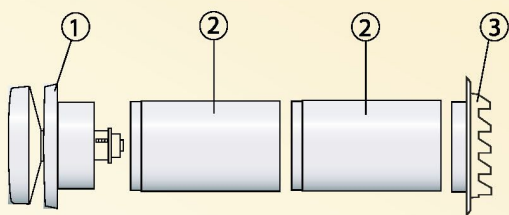

Tłumienie hałasu dla nawiewnika 100 Thermo dB (ref. 10 m²)

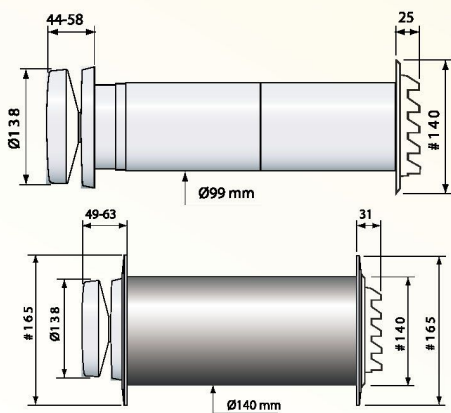
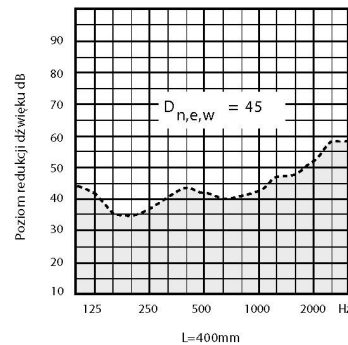
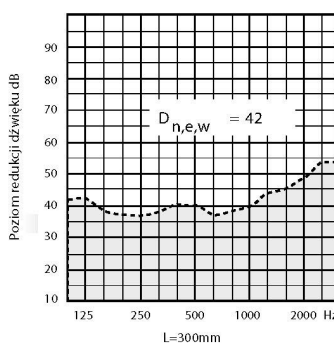
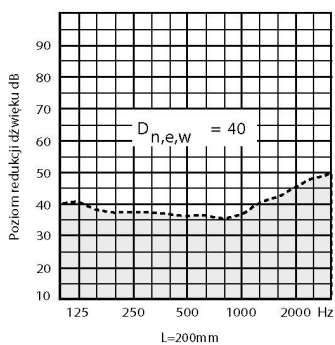

Wydajność

